

CAN总线1

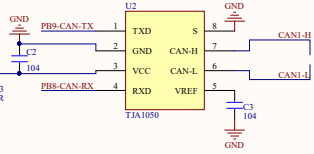

CAN总线2

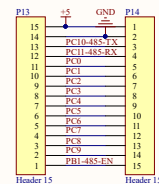
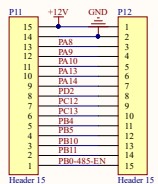
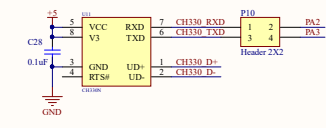
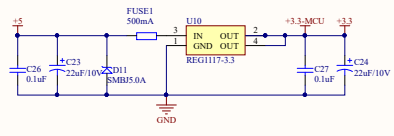
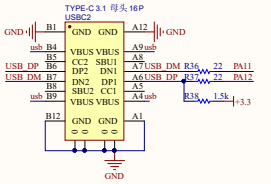
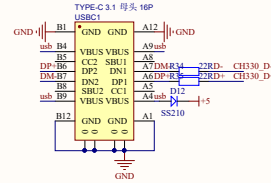
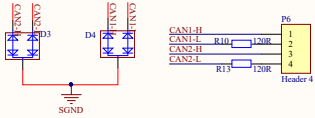
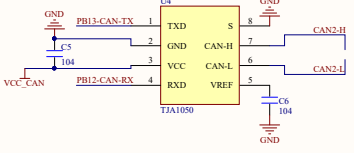

SD CARD

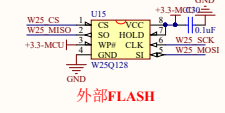
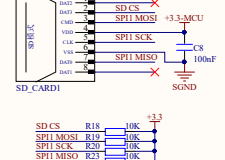

MCU最小系统电路原理

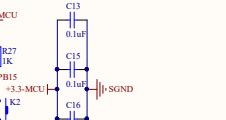
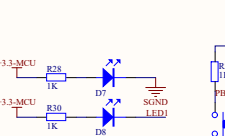
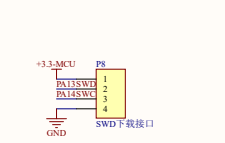
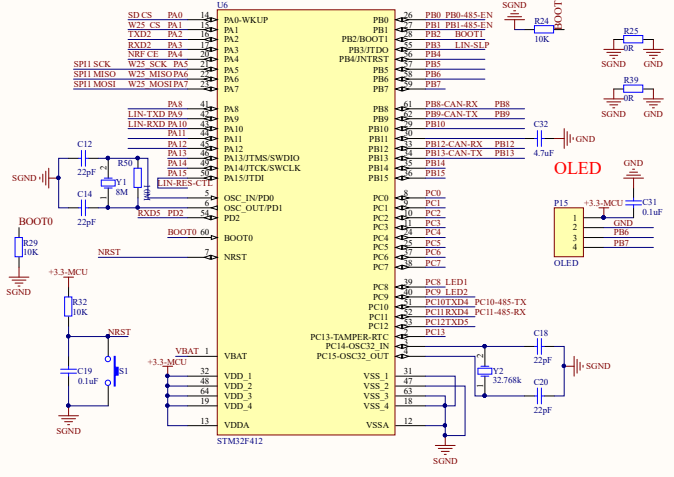

Title		
Size	Number	Revision
A2		
Date:	2022-04-24	Sheet: 9
File:	K:\Cantian\STM32F412R1T6-2022\PCB\STM32F412R1T6_Sch.Dwg	